

TABLE OF CONTENTS

DESCRIPTION OF THE APPLIANCE

BEFORE USING THE REFRIGERATOR

HOW TO OPERATE THE REFRIGERATOR/FREEZER

USE OF THE ICE AND WATER DISPENSER

AUTOMATIC ICE MAKER

COMMON ICE MAKER PROBLEMS

MAINTENANCE AND CLEANING

VACATION

GUIDE TO FOOD STORAGE

TROUBLESHOOTING GUIDE/SERVICE

WATER CONNECTION

DESCRIPTION OF THE APPLIANCE

The model you have purchased may have all or some of the parts and features shown and they may not match the illustration exactly. This manual covers several models.

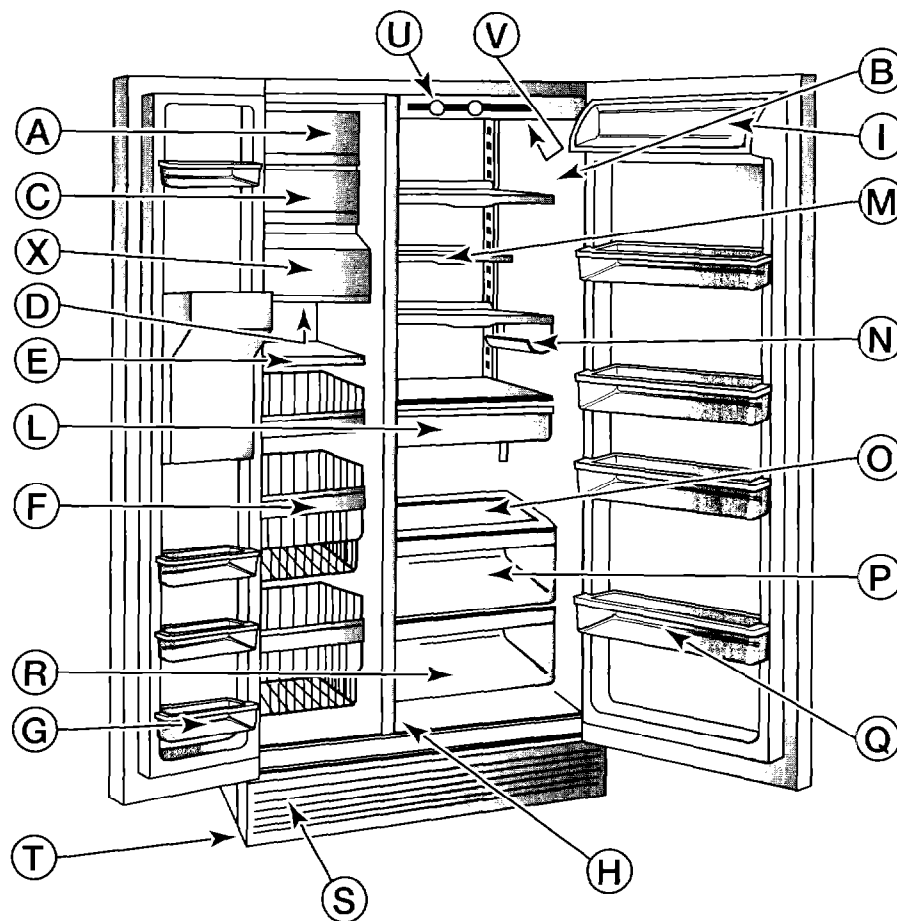

Freezer Compartment

- A - Quick freeze compartment (on some models)
- C - Automatic ice maker
- D - Inside light
- E - Pull-out shelf (the number depends on the model)
- F - Deep shelves (the number depends on the model)
- G - Adjustable and pull-out shelves
- X - Ice bin

Refrigerator Compartment

- B - Rating plate
- H - Meat drawer temperature control
- I - Butter compartment
- L - Snack bin
- M - Adjustable shelf

N - Bottle holder

O - Fruit and vegetable drawer lid

P - Fruit and vegetable drawer with moisture control

Q - Adjustable and pull-out shelves

R - Meat drawer

S - Front grille

T - Defrost pan

U - Control panel

V - Inside light

Control panel

Temperature control slider – freezer compartment

Temperature control slider – refrigerator compartment

DESCRIPTION OF THE APPLIANCE

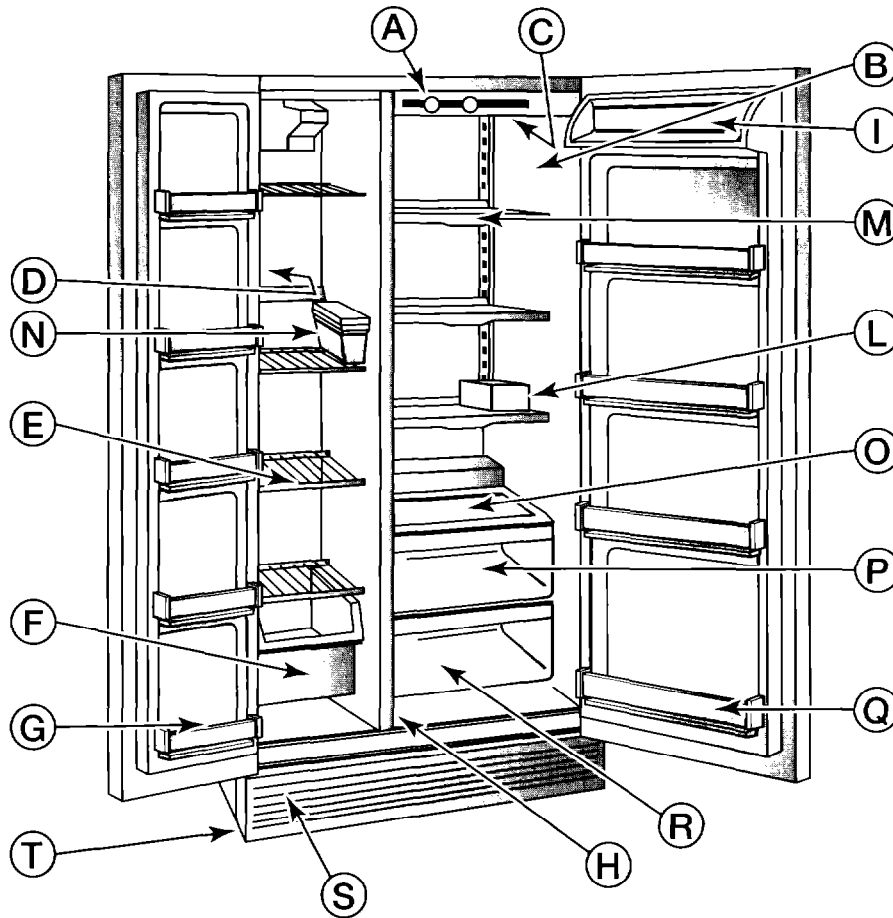

Freezer Compartment

- D - Inside light
- E - Shelf (the number depends on the model)
- F - Deep shelves (the number depends on the model)
- G - Stationary freezer door shelves
- N - Ice cube trays (Ice maker optional)

Refrigerator Compartment

- A - Control panel
- B - Rating plate
- C - Inside light
- H - Meat drawer temperature control
- I - Butter compartment
- L - Eggs container (on some models)

- M - Adjustable shelf
- O - Fruit and vegetable drawer lid
- P - Fruit and vegetable drawer with moisture control
- Q - Stationary door shelves
- R - Meat drawer
- S - Front grille
- T - Defrost pan

Control panel

- Temperature control dial – freezer compartment
- Temperature control dial – refrigerator compartment

BEFORE USING THE REFRIGERATOR

- After unpacking, make sure that the appliance is undamaged and that the door closes perfectly tight. Any damage must be reported to your retailer within 24 hours after delivery of the appliance.
- The packaging box is recyclable and is marked with the recycling symbol ♻.
- The appliance is built with reusable material. When scrapping, follow the local environment protection disposal regulations. To avoid the risk of children being trapped and therefore suffocating, do not allow them to play or hide inside the refrigerator. Render the refrigerator inoperative by removing the doors and cutting the power cable off. Do not dump the appliance. Take it to the local disposal centre so that the refrigerant may be properly recovered and treated.
- Make sure that the installation and the electrical connection are carried out by a qualified technician according to the manufacturer's instructions and local safety regulations.

Precautions and general suggestions

- Use the refrigerator compartment only for the storage of fresh food and the freezer compartment only for the storage of frozen food, the freezing of fresh food, and to make ice cubes.
- After installation, make sure that the refrigerator does not stand on the power cable.
- Do not store glass containers with liquids in the freezer since they may burst.
- Do not eat ice cubes or ice lollies immediately after taking them out of the freezer since they may cause "cold" burns.
- Before carrying out any maintenance or cleaning, always unplug the appliance or disconnect the power supply.
- Do not store or use gasoline or other flammable vapors and liquids in the vicinity of this or any other appliance. The fumes can create a fire hazard or explosion.

Installation

- Make sure that your refrigerator is not near a heat source.
- Place it in a dry and well ventilated room.
- If the refrigerator is installed below a kitchen cabinet, leave a 50 mm gap above the appliance.
- Clean the inside of the refrigerator before using it.
- Let the refrigerator stand (don't move it) for at least one hour before connecting it to the power supply.
- The ice maker should be connected to a water supply that delivers drinkable or chemically purified water.
- Install and level the refrigerator on a floor that will hold the weight and in an area suitable for its size and use.
- Do not use the refrigerator in an area where the room temperature will fall below 13°C.

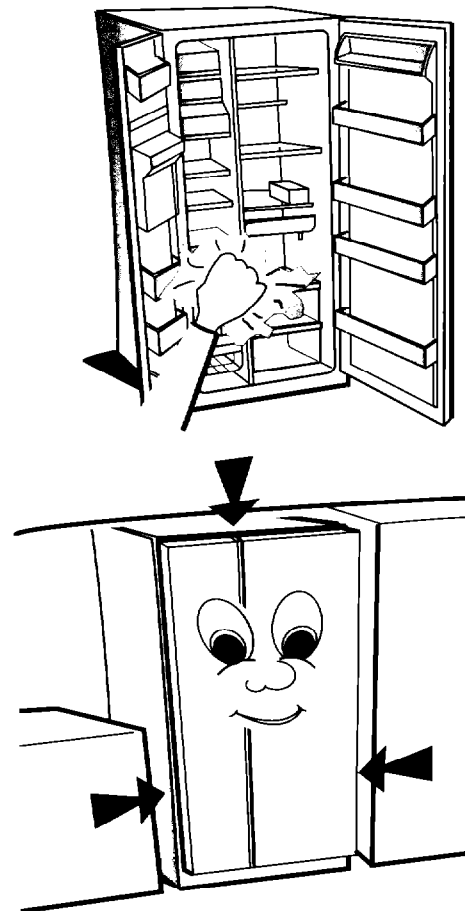

BEFORE USING THE REFRIGERATOR

Declaration of conformity

- This appliance is designed to store food and is manufactured in conformity with EEC directive No. 89/109.
- This appliance has been designed, built, and marketed in compliance with:
 - the safety targets of the Low Voltage EEC Directive 73/23;
 - the protection requirements of the "EMC" EEC Directive 89/336 amended by EEC Directive 93/68.
- This appliance is free of CFC's (refrigerant circuit contains R134a). For more details, please refer to the rating plate on the appliance.

Levelling

If necessary, it is possible to level the appliance by turning the two levelling screws right behind the front grille on the refrigerator bottom, one on the right and the other on the left, proceeding as follows:

- remove the front grille;
- turn one screw or both, clockwise to raise the appliance;
- turn one screw or both, anticlockwise to lower the appliance;
- check if the desired levelling has been reached;
- put the front grille back into place.

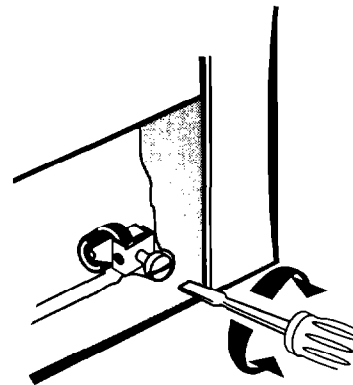

Removal of the front grille

To remove the grille:

- open both doors (refrigerator and freezer);
- pull out the grille frontally to release it from the metal retainers.

At this point it is possible to reach the defrost pan for periodic cleaning, proceeding as follows:

- remove the defrost pan;
- wash the defrost pan with warm water and sodium bicarbonate;
- rinse and dry;
- put the defrost pan back into place with the notched corner to the rear;
- make sure that the defrost drain tube is pointing into the pan;
- put the front grille back into place.

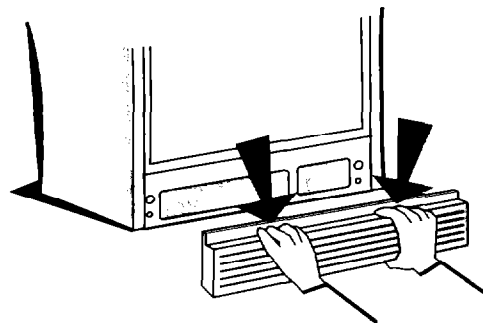

HOW TO OPERATE THE REFRIGERATOR/FREEZER

1. Temperature control (sliders)

When the appliance is used for the first time, set the refrigerator and freezer temperatures on the intermediate position (small triangle); to change these values, move the sliders either left or right: to the **left** for a **less cold** temperature; to the **right** for a **colder** temperature.

How to turn the appliance off:

Move the freezer temperature control slider to the **OFF/ON** position; this operation turns refrigeration off in both the freezer and the refrigerator compartments.

NOTE: Remember that this operation **does not disconnect** the appliance from the power supply.

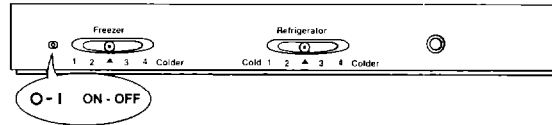

2. Temperature control (thermostat knobs)

The knobs for refrigerator and freezer temperature control are inside the refrigerator. When the appliance is used for the first time:

- set the refrigerator temperature control knob on position 3. It is possible to set the refrigerator temperature from position 1 (less cold) to position 5 (colder);
- set the freezer temperature control knob on position B. It is possible to set the freezer temperature from position A (less cold) to position C (colder) from the very beginning or whenever temperature needs to be changed.

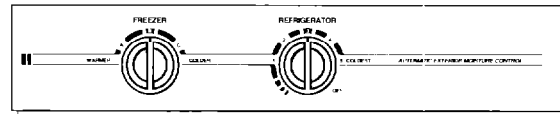

The appliance needs time for the set temperatures to stabilize, so wait before putting food inside.

The mid-range temperature setting recommended in this example is the right one for normal household purposes.

Removal of the shelves of either door

- Take out the sides of the shelf from the inside tabs;
- pull out the shelf frontally.

To reposition it:

- align the shelf with the two side guides on the door;
- push the shelf inside until it is secured in position.

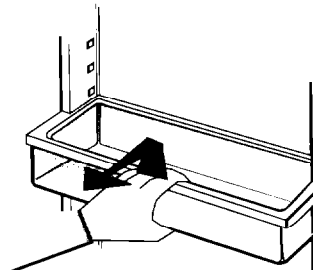

HOW TO OPERATE THE REFRIGERATOR/FREEZER

Rearrangement of the adjustable shelves

Position the shelves according to your needs.

To remove the shelf:

- lift the shelf;
- pull it out frontally.

To reposition the shelf:

- put the shelf above the chosen guides;
- push the shelf on the guides and press downwards.

Removal of the lower shelf on refrigerator door

To allow for easy cleaning, it is possible to remove the toeboard indicated in the drawing by lifting the two ends of the toeboard.

To put the toeboard back:

- align the two ends of the toeboard above the side pockets of the door;
- press the toeboard down until it is secured in position.

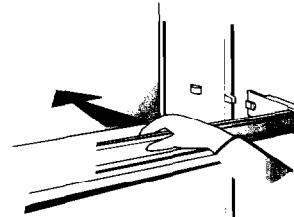
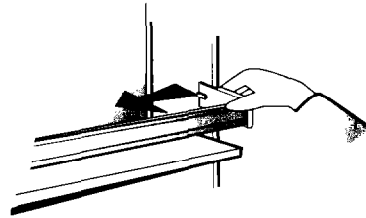

Removal of the snack bin and its lid

To remove the snack bin:

- slide the snack bin out until it stops;
- raise the front side of the bin;
- slide the bin completely out.

To reposition it, carry out the above operations in reverse order.

To remove the lid:

- raise the front side of the lid and then the back side;
- pull outwards.

To reposition, carry out the above operations in reverse order.

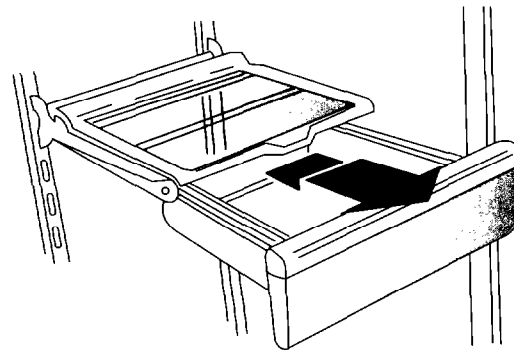

Use of the hanging bottle holder

This bottle holder can accommodate 1 bottle:

Hang it under the right or left side of any refrigerator shelf.

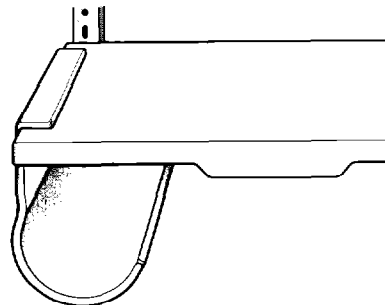

HOW TO OPERATE THE REFRIGERATOR/FREEZER

Rearrangement of the refrigerator shelves

It is possible to position the shelves according to your needs.

The glass shelves are strong enough to hold bottles, milk cartons, and heavy food; however, please don't bang them on the shelves.

To remove the shelves:

- lift the front;
- slide the shelf outwards until it stops;
- lift the front and slide the shelf completely out.

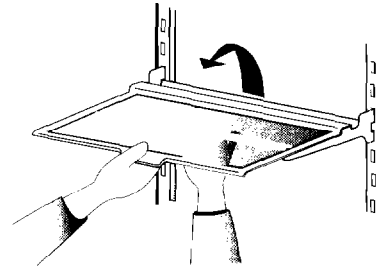

Rearrangement of the sliding glass shelf inside the refrigerator (on some models)

The glass shelf may slide from one side of the refrigerator to the other for greater convenience in storing food.

To slide the shelf:

- slightly raise the front side;
- slide it into the desired position;
- lower the front side back to its level position.

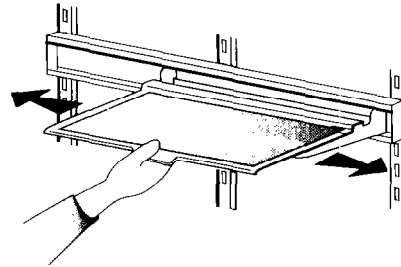

To remove the shelf:

- hold the back side of the shelf firmly with one hand;
- raise the front side until it reaches a 45° angle;
- slowly lower it until the hooks of the rail on the back panel of the refrigerator come loose;
- pull the shelf out from the front.

NOTE: this shelf is rather heavy so use both hands when you remove it.

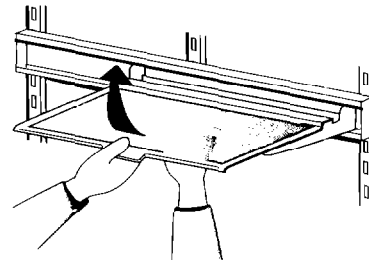

Removal of the meat drawer and of its lid

To remove the meat drawer:

- slide the meat drawer out until it stops;
- lift the front of the drawer;
- slide the drawer completely out.

To remove the lid:

- remove the meat drawer and the fruit and vegetables drawer;
- lift the front of the lid and remove it from the supports;
- pull the lid upwards and take it out.

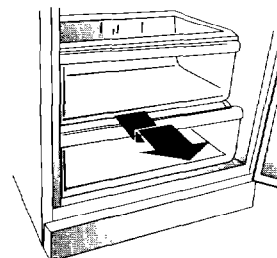

Meat drawer temperature control

The cold air flows inside the meat drawer through an opening between the refrigerator and the freezer compartment. This helps to keep the meat drawer colder than the rest of the refrigerator. Set the slider for higher or lower airflow.

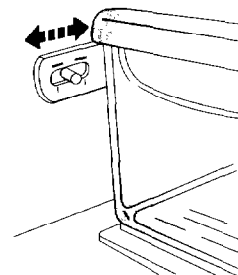

HOW TO OPERATE THE REFRIGERATOR/FREEZER

Removal of the fruit and vegetable drawer and of its lid

The glass lid covers the entire width of the fruit and vegetable drawer.

Before removing the lid, the drawer must be pulled out:

- slide the drawer outwards until it stops;
- lift the front of the drawer;
- pull out the drawer completely.

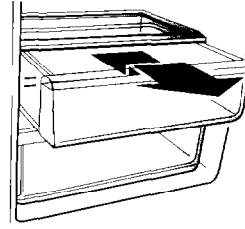

To remove the lid:

- lift the front of the lid to release it from the supports;
- take out the lid by lifting it and pulling it outwards.

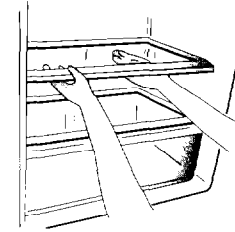

To put the lid back:

- insert the back of the lid in the supports on the refrigerator walls;
- lower it back into place.

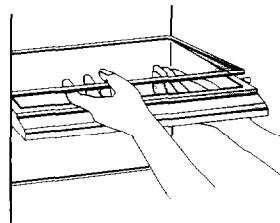

Fruit and vegetable drawer moisture control

It is possible to control the moisture in the fruit and vegetable drawer:

- the control may be set in any position from LOW to HIGH.
- LOW excludes damp air from the drawer for better preservation of fruits and vegetables with peel.
- HIGH keeps damp air inside the drawer for better preservation of leafy vegetables.

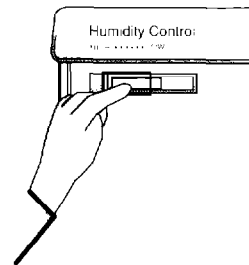

Removal of the freezer compartment shelf

To remove the shelf:

- lift the right side from the supports;
- slide the shelf out of the supports on the left;
- put it back proceeding in reverse order.

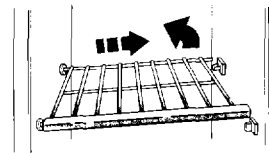

Removal of the freezer compartment deep shelves

- slide the deep shelf outwards until it stops;
- lift the front to release the deep shelf from the retainer;
- pull out the deep shelf completely.

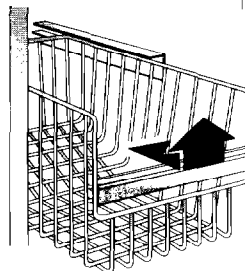

USE OF THE ICE AND WATER DISPENSER

To dispense ice:

1. For ice cubes, slide the switch to CUBE position CUBE ICE CRUSHED.

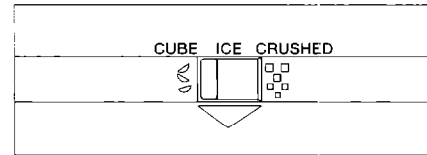

For crushed ice, slide the switch to CRUSHED position (if available) CUBE ICE CRUSHED.

2. Press a sturdy glass against the ice cube dispenser bar.
3. Take away the glass to stop dispensing.

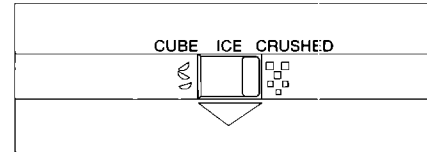

NOTE: The first few batches of ice cubes may have an off-taste. Throw this ice away. Ice is dispensed from the ice maker bin in the freezer compartment. When the outside dispenser bar is pressed, a trapdoor opens between the ice bin and the dispenser. When the glass is taken away from the dispenser bar, a buzzing sound may be heard for a few seconds as the trapdoor closes. The dispenser will not operate when the freezer compartment door is open.

NOTE: Large amounts of ice cubes should be taken directly from the bin, not through the dispenser. For crushed ice, cubes are crushed before being dispensed. This may cause a slight delay in dispensing crushed ice. Noise from the ice crusher is normal, and pieces of ice may vary in size.

When changing from crushed ice to ice cubes, a small quantity of crushed ice will be dispensed along with the first cubes. After starting the appliance, 3 to 4 hours are normally required to obtain the first ice cubes.

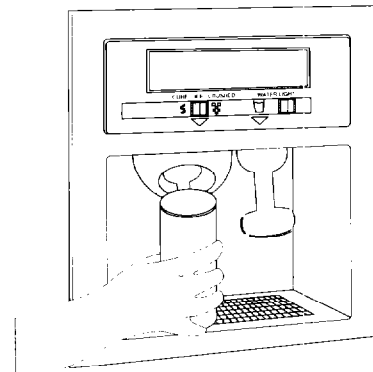

USE OF THE ICE AND WATER DISPENSER

To dispense water:

1. Press a sturdy glass against the water dispenser bar.
2. Take away the glass to stop dispensing.

NOTE: Dispense enough water every week to renew the cold water reserve.

Chilled water comes from a tank behind the meat drawer. It holds about 1.5 litres. When you use it for the first time, press the water dispenser with a glass or jar until you have drawn and discarded enough water to drain and rinse the tank and pipes. Throw this water away.

Allow several hours to chill the first tankful.

NOTE: The small tray beneath the dispenser is designed to evaporate small spills. There is no drain in this tray. Do not pour water into it.

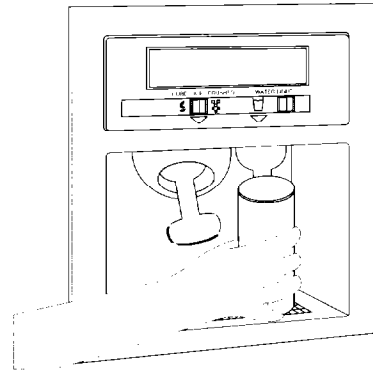

AUTOMATIC ICE MAKER

Useful hints on the automatic ice maker

- The ON/OFF lever is a signal arm:
Down for making ice automatically.
Up to switch off the ice maker.

NOTE: Do not turn the ice maker on until it is connected to the water supply.

- It is normal for ice cubes to be attached by a corner. They will break apart easily.
- The ice maker will not operate until the freezer compartment is cold enough to make ice. This can take overnight.
- If ice is not being made fast enough and more ice is needed, set the refrigerator thermostat on a higher number. Wait a day and, if necessary, set the freezer compartment thermostat knob on "4/5."
- Good water quality is important for good ice quality. Water softener chemicals such as salt can damage the ice maker and lead to poor quality ice.

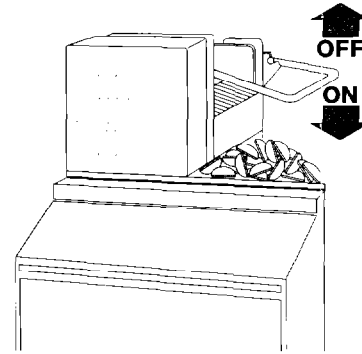

Removing the ice maker bin

Remove, empty, and clean the bin:

- if the ice dispenser has not been or will not be used for a week or more;
- if a power failure causes ice in the bin to melt and freeze together;
- if the ice dispenser is not used regularly.

AUTOMATIC ICE MAKER

To remove the bin

1. Pull the covering panel out from the bottom and slide it to the rear.

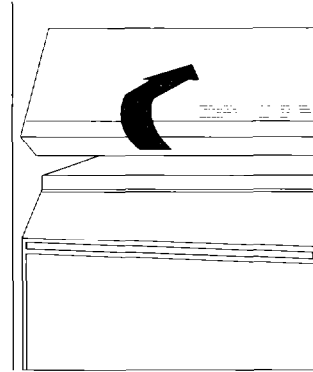

2. Lift the signal arm to the OFF position. Ice can still be dispensed, but no more will be made.
3. Lift the front of the bin and pull it out.
4. Empty the bin. Use warm or lukewarm water to melt the ice if necessary. Do not use sharp tools to break up the ice in the bin. This can damage the bin and the dispenser mechanism.
5. Wash following the instructions given under chapter "Maintenance and Cleaning". Rinse well. Do not use abrasive cleaners or solvents.
6. When putting the bin back, make sure it is pushed all the way in. Push the signal arm down to the ON position to restart ice cubes production.

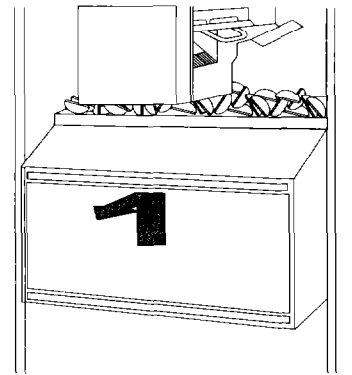

To turn the night light on, slide the LIGHT switch to the left.

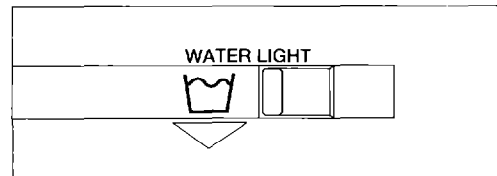

COMMON ICE MAKER PROBLEMS

Common ice maker problems

PROBLEM	CAUSE	SOLUTION
The dispenser does not work.	<p>The freezer compartment door is open.</p> <p>The ice bin is not properly installed.</p>	<p>Close the freezer compartment door.</p> <p>Make sure that the bin is pushed all the way in.</p>
The ice dispenser stops working.	<p>The dispenser has not been used for extended periods, causing the ice cubes to melt together.</p> <p>The ice dispenser bar has been held in for too long.</p>	<p>Shake the bin occasionally to keep cubes separate and to increase storage capacity. Throw old ice cubes away and make a new supply.</p> <p>Wait about 3 minutes for the dispenser motor to reset. Large amounts of ice should be taken from the bin, not through the dispenser.</p>
Off-taste or odour in ice.	<p>Ice absorbs airborne odours.</p> <p>Water quality.</p> <p>Food not properly wrapped.</p> <p>The ice bin and the freezer compartment may need cleaning.</p> <p>Plumbing to ice maker.</p>	<p>New ice maker. Throw old ice away and make new supply.</p> <p>Store excess ice in a covered container. Water containing minerals may require a filter.</p> <p>Wrap food properly.</p> <p>Clean the ice bin and the freezer. Follow instructions for a proper water supply to ice maker.</p> <p>The first few batches of ice from a new ice maker may have an off-taste. Throw the ice away and make a new supply.</p>

NOTE: Only use cubes from the ice maker.

MAINTENANCE AND CLEANING

Before carrying out any maintenance or cleaning, always unplug the appliance or disconnect the power supply.

Periodically clean the refrigerator and freezer compartments with a sponge dampened in a solution of lukewarm water and vinegar. Rinse and dry. Never use detergents or abrasives. Never clean refrigerator parts with flammable fluids. The fumes can create a fire hazard or explosion.

Clean the outside with a sponge dampened in lukewarm water.

Dry with a soft cloth.

Periodically clean the defrost pan proceeding as follows:

- remove the front grille;
- remove the defrost pan;
- wash the defrost pan with warm water and mild detergent;
- rinse and dry;
- put the defrost pan back into place with the notched corner to the rear;
- make sure that the defrost drain tube is pointing into the pan;
- put the front grille back into place.

NOTE: The refrigeration system tubes are located near the defrost pan and can become hot. Periodically clean them with a vacuum cleaner.

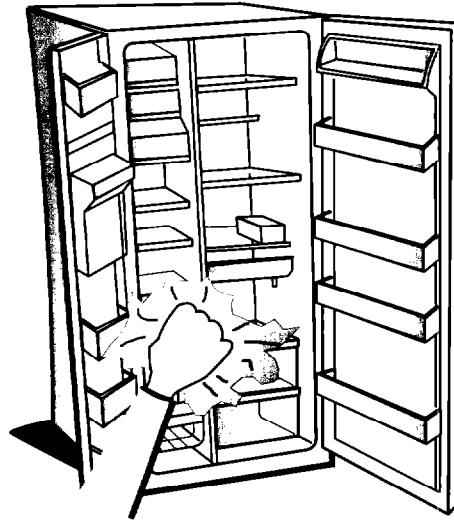

MAINTENANCE AND CLEANING

How to replace the refrigerator bulb

- reach for the bulb behind the control panel;
- remove the bulb;
- replace it with one of the same type available only at our Service Centres or Retailers.

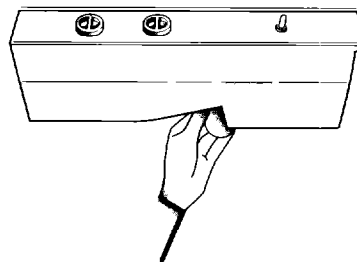

How to replace the freezer upper compartment bulb

- remove the light shield by grabbing its upper central part;
- pull frontally and, at the same time, slightly turn the shield to one side;
- remove the bulb and replace it with one of the same type available only at our Service Centres or Retailers.

To put the light shield back into place:

- grab the upper central part of the light shield;
- insert the tabs of one side of the shield into the grooves;
- gently bend the light shield in the centre to insert the tabs on the other side.

How to replace the dispenser bulb (on some models)

- reach for the bulb in the dispenser recess;
- remove the bulb and replace it with one of the same type available only at our Service Centres or Retailers.

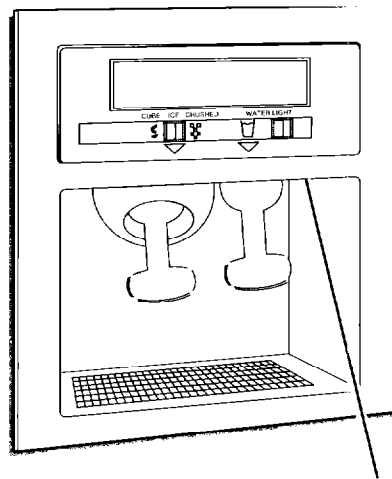

Dispenser light

VACATION

Short vacation

There is no need to disconnect the refrigerator from the power supply if you will be away for less than three weeks. Use up perishable food, freeze other food. If your appliance has an automatic ice maker:

1. Turn it off.
2. Shut off the water supply to the ice maker.
3. Empty the ice bin.

Long vacation

Remove all the food if you are going away for three weeks or more. If your appliance has an automatic ice maker, turn off the water supply to the ice maker at least a day before.

When the last batch of ice cubes drops, turn off the ice maker.

Unplug the refrigerator and clean it, rinse, and dry. Fix some wooden or plastic wedges to the upper part of both doors with adhesive tape and leave the doors open enough for air to circulate inside both compartments. This will prevent odour and mould from setting in.

Moving

- Take out all removable parts, wrap them well, and fix them together with adhesive tape so that they will not come loose or shake.
- Tighten the front levelling screws.
- Close and fix both doors with adhesive tape and, again using adhesive tape, fix the power cable to the appliance.

Power failure

In case of power failure, call the local office of your Electricity Company and ask how long it is going to last.

1. Should the power failure last 24 hours or less, **keep both doors of the appliance closed**. This will allow the stored food to stay cold as long as possible.
2. Should the power failure last more than 24 hours, remove all frozen food and put it in a freezer with a key lock. If this type of freezer is not available and, likewise, no artificial ice packs are available, try to use up the food which is more easily perishable.

3. Bear in mind that a full freezer compartment will stay cold longer than a partially filled one.
Furthermore, a freezer full of frozen meat will stay cold longer than a freezer filled with pre-cooked food.

If the food still shows ice crystals, it is possible to refreeze it without running any risk; however, it will probably change taste and flavour. If the condition of the food is definitely poor and you feel like you would be running a risk by refreezing it, you must throw it away.

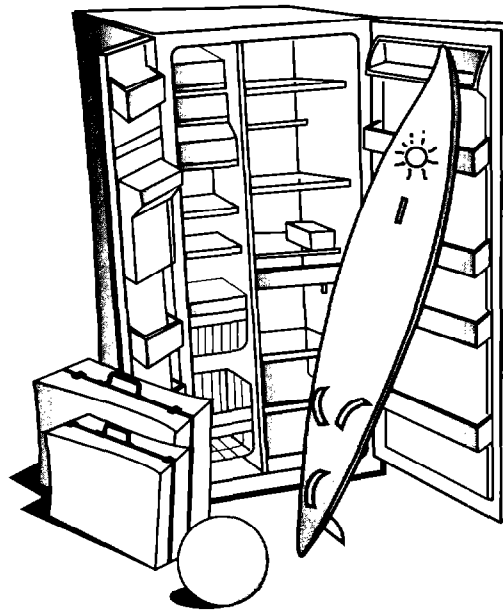

GUIDE TO FOOD STORAGE

The freezer compartment, marked with the ❄️ symbol, allows the storage of frozen food as well as the freezing of fresh or cooked food. It also allows the making of ice cubes.

Freezing

The maximum quantity of food which can be frozen in a 24 hour period, at an ambient temperature of 25°C, is 6 kg.

Set the "FREEZER" control knob of the freezer compartment to its coldest setting.

Freezing of fresh food and automatic ice making cannot be carried out at the same time. Therefore do not forget to stop the automatic ice maker by setting the lever on OFF. See the operating instructions in chapter "Automatic ice maker".

Do not store warm food in the freezer; do not refreeze already thawed food; it is possible to freeze it after cooking. Wrap food in aluminium foil or plastic film or place it into appropriate containers. Label the wrappings and mark the freezing date and the contents.

The freezer compartment maintains the adequate storage temperature even during a power failure, for a period of approximately 12 hours. However, during this time, we suggest you leave the freezer door closed.

Preparing fresh food for freezing

It is important to wrap food so that no water, moisture or vapour may pass through; this avoids the transfer of odour or flavour throughout the refrigerator and allows better storage of frozen food.

We recommend the use of plastic containers with tight fitting lids, aluminium trays, aluminium foil, plastic film, and, waterproof plastic wrappings.

Sealing

When sealing the food in bags, squeeze out the air (liquids need head space to allow for expansion).

Fasten the top of the bag with a string.

Put the label inside transparent bags; use self-adhesive labels on the outside of opaque ones.

Freezing fruit

Select ripe, blemish-free fruit. Clean, peel, and slice as needed. Pack in rigid containers or other recommended material. Leave some head space to allow liquid to expand during freezing.

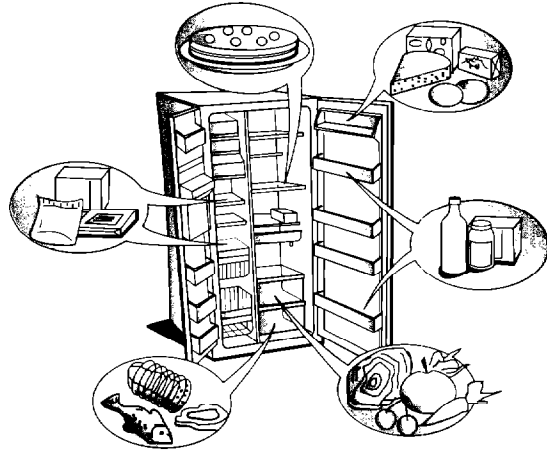

Freezing vegetables

For best results freeze no more than 2 to 3 hours after picking. Wash in cold water, clean and cut as needed. Blanch. Pack in recommended containers and freeze.

Do not freeze lettuce, celery, carrot sticks, potatoes, or fresh tomatoes. All will become limp or mushy. Tomatoes will collapse when thawed.

Freezing meat

Thawed meat will be as good as before freezing.

Steaks or flat cuts should be wrapped individually or in layers separated by a double sheet of freezer wrap.

Freezing cooked food

Cook your food as you would for the table: Shorten the cooking time 10 to 15 minutes to allow for additional cooking during reheating. Do not season and remove part of the cooking liquid. Remember to add them when reheating. Cool as rapidly as possible and freeze at once. Liquid or semi-liquid dishes must be frozen in recommended containers leaving some head space to allow for expansion. Casseroles and other more solid food can be frozen in oven proof containers.

GUIDE TO FOOD STORAGE

Freezing pastry and bread

Wrap bread in recommended material. Thaw inside the wrapping. Unbaked yeast bread can be frozen after the first rising. Punch down, wrap and freeze.

Bake cookies and pastry as usual. Cool and freeze on trays, then pack in recommended freezer bags or cartons. Unbaked cookies and pastry may be dropped, moulded, or rolled and frozen on trays. Store in bags or cartons. Bake without thawing.

Fruit pies are best frozen unbaked. Bake without thawing.

Food storage chart

Storage time will vary according to the quality of the food, the type of packaging or wrap used (moisture and vapour proof), and the storage temperature (which should be -18°C).

FOOD STORAGE TIME

FRUIT

Fruit juice concentrate	12 months
Fruit (general)	8 to 12 months
Citrus fruit and juice	4 to 6 months

VEGETABLES

Commercially frozen	8 months
Home frozen	8 to 12 months

MEAT

Sausages	4 weeks or less
Hamburgers	1 month
Beef, veal, lamb	2 to 3 months

Roasts

Beef	6 to 12 months
Lamb and veal	6 to 12 months
Pork	4 to 8 months
Fresh sausages	1 to 2 months

Steaks and chops

Beef	8 to 12 months
Lamb, veal, pork	2 to 4 months

FISH

Cod, flounder, sole	6 months
Salmon	2 to 3 months
Mackerel, perch	2 to 3 months

Battered fish (purchased)	3 months
Clams, oysters, cooked fish, crab	3 to 4 months
Raw shrimp	12 months

POULTRY

Chicken or turkey (whole or parts)	12 months
Duck and goose	6 months
Giblets	2 to 3 months
Cooked poultry with gravy	6 months
Cuts (no gravy)	1 month

STEWES

Meat, poultry, and fish	2 to 3 months
-------------------------	---------------

DAIRY PRODUCTS

Butter	6 to 9 months
Margarine	12 months

Cheese

Camembert, mozzarella, cottage	3 months
Creamy cheeses	do not freeze
Brie, Emmenthal, Suisse, etc.	6 to 8 weeks (Freezing may alter cheese texture)
Ice cream, fruit juices, milk	12 months

EGGS

Whole (beaten), whites, yolk	12 months
(Add sugar or salt to yolks or whole beaten eggs)	

PASTRY AND BREAD

Yeast bread and rolls	3 months
Unbaked bread	1 month
Croissants	3 months
Cakes (unfrosted)	2 to 4 months
Cakes (frosted) and baked cookies	6 to 12 months
Fruit pies	12 months
Cookie dough	3 months
Pie dough	4 to 6 months

We remind you that, in case of power failure, the freezer compartment maintains the appropriate storage temperature for approximately 12 hours; during this time, we suggest you leave the door of the compartment closed.

Do not refreeze partially thawed food.

GUIDE TO FOOD STORAGE

Thawing

Here are some helpful hints:

Raw vegetables: do not thaw, put straight into boiling water and cook as usual.

Meat (large cuts): thaw in the refrigerator compartment without unwrapping. Before cooking, leave at room temperature for a couple of hours.

(small cuts): thaw at room temperature or cook directly.

Fish: thaw in the refrigerator compartment without unwrapping or cook directly before complete thawing.

Previously cooked food: reheat in the oven without removing it from its aluminium container.

Fruit: thaw in the refrigerator compartment.

NOTE: Never store warm food in the freezer.

TROUBLESHOOTING GUIDE/SERVICE

Before calling for Service...

Performance problems often result from little things you can find and fix yourself without tools of any kind.

If your refrigerator will not work:

- Is the power cable plugged into a live socket with the proper voltage?
- Have you checked your home's fuses?
- Is the thermostat in the right position?



If there are noises or vibrations:

Most of the noises are normal. Hard surfaces like the floor, walls, and cabinets can make the noises seem louder. The following describes the most common types of noises and what may be making them:

• Slight hum

You may be hearing the refrigerator's fan motor and moving air.

• Clicking noises

The thermostat clicks when the refrigerator stops running. It also makes a sound when the refrigerator starts. The defrost timer clicks when the defrost cycle starts and stops.

• Water noises

When the refrigerator stops running, you may hear a gurgling noise in the piping for a few minutes. You may also hear the defrost water running into the defrost water pan.

• Ice maker noises

Since your appliance has an ice maker, you may hear buzzing (from the water valve), trickling water, and the clatter of the ice falling into the bin.

If your ice maker will not work:

- Has the freezer had enough time to become cold?
With a new refrigerator this may take overnight.
- Is the lever in the down position (ON)?
- Is the water turned on? Is water getting to the ice maker?

If there is water in the defrost pan:

- This is normal in hot, damp weather. The pan can even be half full. Make sure the refrigerator is level so that the water does not overflow.

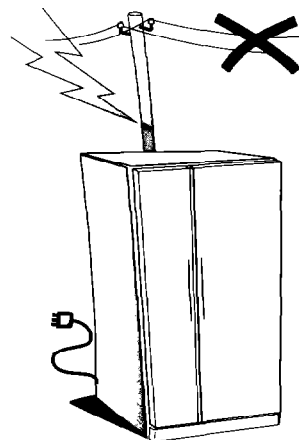

If the light does not work:

- Have you checked your home's fuses?
- Is the power cable plugged into a live socket with the proper voltage?

In case of burned out bulbs:

1. Always pull the plug out of the socket.
2. Reach for the bulb behind the control panel.
3. Remove the bulb.
4. Replace it with one of the same type available only at our Service Centres or Retailers.

If the motor seems to run too much:

- Is the condenser free of dust and lint?
- On hot days or if the room is warm, the motor naturally runs longer.
- If the door has been opened a lot or if a large amount of food has been stored, the motor will run longer to cool down the interior.

TROUBLESHOOTING GUIDE/SERVICE

Remember:

Motor running time depends on different things: Number of door openings, amount of food stored, temperature of the room, setting of the temperature controls.

If you have followed the above checks and your appliance still does not work properly, get in touch with the After Sale Service. State clearly what is wrong and the type and serial number of your appliance (these data are on the rating plate).

To replace the power cable:

You must ask our After Sale Service to replace the power cable.

WATER CONNECTION

- We recommend you have a qualified plumber or the After Sale Service perform the water connection.
- Unplug the appliance before performing the water connection. Failure to do so can result in death or electrical shock.
- The appliance has a rubber hose 1,500 mm long to make the connection easier.
- Remove the panel (A) (Fig. 1) and unscrew the cap (B).
- Connect the pipe end fitted with the metal locknut (C) to the refrigerator's solenoid valve (D) (Fig. 2), using the ring gaskets.
- The appliance may work with water pressures from 1 to 7 atm.
- Turn the water tap on and check that there are no leaks.
- The appliance does not need to be set nor does it need a water drain.

NOTE: We recommend, in any case, to comply with local regulations on connections to water supply.

